

Technical data sheet

Locknut, metric thread, light grey

Item number: 2048906



Locknut DIN 46319, with metric thread IEC 423.



PA Polyamide

Master data

Item number	2048906
Description 1	Locknut
Manufacturer	OBO
Dimension	M12
Colour	Light grey; RAL 7035
Material	Polyamide
Smallest sales unit	100
Unit of quantity	Piece
Weight	0.1 kg
Weight unit	kg/100 pc.

Technical data sheet

Locknut, metric thread, light grey

Item number: 2048906



Dimensions



Dimension E	19 mm
Dimension L	5 mm

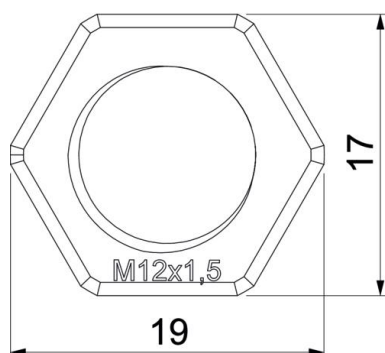

Technical data

Thread	M12_x_1,5
Thread type	Metric
Nominal thread size metric/PG	12
Fibre-glass reinforced	no
Halogen-free	yes
Impact-resistant	no
WAF	17