

Technical data sheet

Locknut, metric thread, light grey

Item number: 2048922



Locknut DIN 46319, with metric thread IEC 423.



PA Polyamide

Master data

Item number	2048922
Description 1	Locknut
Manufacturer	OBO
Dimension	M20
Colour	Light grey; RAL 7035
Material	Polyamide
Smallest sales unit	100
Unit of quantity	Piece
Weight	0.173 kg
Weight unit	kg/100 pc.

Technical data sheet

Locknut, metric thread, light grey

Item number: 2048922



Dimensions



Dimension E	29 mm
Dimension L	6 mm

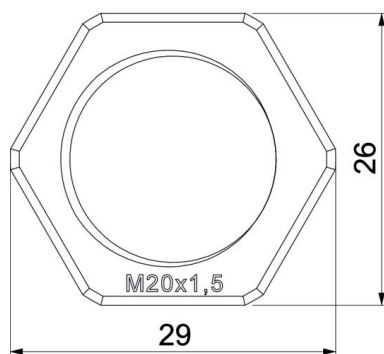

Technical data

Thread	M20_x_1,5
Thread type	Metric
Nominal thread size metric/PG	20
Fibre-glass reinforced	no
Halogen-free	yes
Impact-resistant	no
WAF	26