

# Technical data sheet

Locknut, metric thread, light grey

Item number: 2048965



Locknut DIN 46319, with metric thread IEC 423.



PA Polyamide

## Master data

Item number	2048965
Description 1	Locknut
Manufacturer	OBO
Dimension	M50
Colour	Light grey; RAL 7035
Material	Polyamide
Smallest sales unit	25
Unit of quantity	Piece
Weight	0.89 kg
Weight unit	kg/100 pc.

# Technical data sheet

Locknut, metric thread, light grey

Item number: 2048965



## Dimensions



Dimension E	68 mm
Dimension L	8 mm

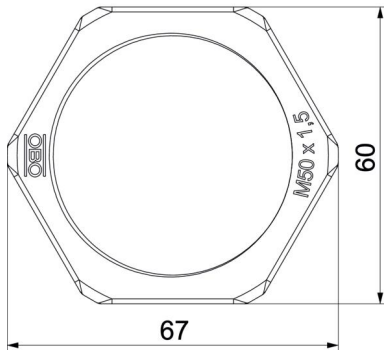

## Technical data

Thread	M50_x_1,5
Thread type	Metric
Nominal thread size metric/PG	50
Fibre-glass reinforced	no
Halogen-free	yes
Impact-resistant	no
WAF	60